



**HarmonicShield® Series Drive-Applied Harmonic Filter
Installation, Operation, and Maintenance Manual**



TCI, LLC
W132 N10611 Grant Drive
Germantown, Wisconsin 53022

Phone: 414-357-4480
Fax: 414-357-4484
Helpline: 800-TCI-8282
Web Site: www.transcoil.com

© 2017 TCI, LLC All rights reserved

Performance Guarantee

Select & install the appropriate HarmonicShield® Harmonic Filter in a variable torque, variable frequency AC drive application, within our published technical specifications & we guarantee that the input current distortion will be less than or equal to 5% THID for standard HSD Series filters at full load, and less than 8% at 30% load. If a properly sized & installed filter fails to meet its specified THID level, TCI will provide material for necessary modifications or replacement filter at no charge.

HSD filters can also provide similar performance in other drive applications such as constant torque, DC drives & other phase controlled rectifiers, but actual THID levels can vary by load and/or speed & therefore cannot be guaranteed.

Consult factory for assistance when applying HSD filters on these types of equipment.

MINIMUM SYSTEM REQUIREMENTS:

The guaranteed performance levels of this filter will be achieved when the following system conditions are met:

Frequency: 60Hz \pm 0.75Hz

System Voltage: Nominal System Voltage (line to line) \pm 10%, No more than 1.5% Source inductance

Balanced Line Voltage: Within 0.5%

Background Voltage Distortion: < 0.5% THVD

The input VFD current waveform shall be consistent with that of a VFD with 3% AC line reactance at full load.

NOTE: The presence of background voltage distortion will cause motors & other linear loads to draw harmonic currents.

Additional harmonic currents may flow into the HSD filter if there is harmonic voltage distortion already on the system.

Revision	Description	Date
A	Release	08/01/16
B	Added SCCR Statement	09/12/16
C	Updates to torques and specs	10/12/16
D	Update to Installation Instructions & Technical Specifications	9/13/17

No part of this publication may be reproduced, stored in a retrieval system, or transmitted in any form or by any means, mechanical, electronic, photocopying, recording, or otherwise, without the prior written permission of TCI, LLC. The information in this manual is subject to change without notice. Every precaution has been taken in the preparation of this manual. TCI, LLC assumes no responsibility for errors or omissions. Neither is any liability assumed for damages resulting from the use of the information contained in this publication

Table of Contents

Introduction	1
Receiving Inspection and Storage	3
Pre-installation Planning	5
Installation Guidelines	6
Connections	7
HSD Filter Operation.....	8
Installation	9
Maintenance and Service	10
Product Description	11
Standard Product Ratings and Dimension Tables.....	15
Standard Option (S)	18
Product Description.....	18
Contactors Option (C)	19
Lugs Option (L)	20
Filter Operation	21

Introduction

Safety Instructions Overview

This section provides the safety instructions which must be followed when installing, operating, and servicing the HarmonicShield® (HSD) filter. If neglected, physical injury or death may follow, or damage may occur to the filter or equipment connected to the HSD filter. The material in this chapter must be read and understood before attempting any work on, or with, the product.

The HSD filter is intended to be connected to the input terminals of one or more VFDs. Three-phase power is connected to the input terminals of the HSD and power is supplied to the VFD or VFDs through the HSD. The instructions, and particularly the safety instructions, for the VFDs, motors, and any other related equipment must be read, understood, and followed when working on any of the equipment.



Warnings and Cautions

This manual provides two types of safety instructions. Warnings are used to call attention to instructions that describe steps that must be taken to avoid conditions that can lead to a serious fault condition, physical injury, or death.

Cautions are used to call attention to instructions that describe steps that must be taken to avoid conditions that can lead to a malfunction and possible equipment damage.

Warnings

Readers are informed of situations that can result in serious physical injury and/or serious damage to equipment with warning statements highlighted by the following symbols:

<p>Warning</p> 	<p>Dangerous Voltage Warning: warns of situations where high voltage can cause physical injury and/or damage equipment. The text next to this symbol describes ways to avoid the danger.</p>
<p>Warning</p> 	<p>General Warning: warns of situations that can cause physical injury and/or damage equipment by means other than electrical. The text next to this symbol describes ways to avoid the danger.</p>
<p>Warning</p> 	<p>Electrostatic Discharge Warning: warns of situations in which an electrostatic discharge can damage equipment. The text next to this symbol describes ways to avoid the danger.</p>







Cautions

Readers are informed of situations that can lead to a malfunction and possible equipment damage with caution statements:

<p>Caution</p> 	<p>General Caution: identifies situations that can lead to a malfunction and possible equipment damage. The text describes ways to avoid the situation.</p>
---	---

General Safety Instructions

These safety instructions are intended for all work on the HSD. Additional safety instructions are provided at appropriate points on other sections of this manual.

<p>Warning</p> 	<p>Be sure to read, understand, and follow all safety instructions.</p>
<p>Warning</p> 	<p>Only qualified electricians should carry out all electrical installation and maintenance work on the HSD filter.</p>
<p>Warning</p> 	<p>All wiring must be in accordance with the National Electrical Code (NEC) and/or any other codes that apply to the installation site.</p>
<p>Warning</p> 	<p>The HSD does not have any user serviceable parts. Please return your filter to TCI for servicing or refer service to TCI authorized service personnel. Failure to do so can void your product warranty.</p>
<p>Warning</p> 	<p>Disconnect all power before working on the equipment. Do not attempt any work on a powered HSD filter.</p>
<p>Warning</p> 	<p>The HSD filter, drive, motor, and other connected equipment must be properly grounded.</p>
<p>Warning</p> 	<p>After switching off the power, always allow 5 minutes for the capacitors in the HSD filter and in the drive to discharge before working on the HSD, the drive, the motor, or the connecting wiring. It is a good idea to check with a voltmeter to make sure that all sources of power have been disconnected and that all capacitors have discharged before beginning work.</p>

Receiving Inspection and Storage

Thank you for selecting the HarmonicShield® (HSD) filter. TCI has produced this filter for use in many variable frequency drive (VFD) applications that require input power line harmonic current reduction. This manual describes how to install, operate and maintain the HSD filter.

Receiving Inspection

The HSD filter has been thoroughly inspected and functionally tested at the factory and carefully packaged for shipment. When you receive the unit, you should immediately inspect the shipping container and report any damage to the carrier that delivered the unit. Verify that the part number of the unit you received is the same as the part number listed on your purchase order.

Storage Instructions

If the HSD filter is to be stored before use, be sure that it is stored in a location that conforms to published storage humidity and temperature specifications stated in the HSD Technical Specifications. Store the unit in its original packaging.

TCI Limited Warranty Policy

TCI, LLC (“TCI”) warrants to the original purchaser only that its products will be free from defects in materials and workmanship under normal use and service for a period originating on the date of shipment from TCI and expiring at the end of the period described below:

<u>Product Family</u>	<u>Warranty Period</u>
KDR, KLR	For the life of the drive with which they are installed.
V1K, KMG	One (1) year of useful service, not to exceed 18 months from the date of shipment.
HGA	One (1) year of useful service, not to exceed 18 months from the date of shipment. The warranty for active filters may be extended to 30 months of useful service and 42 months from date of shipment with the purchase of an extended warranty and start-up service. See active filter warranty policy for details.
PFG, HGP, HG7, KRF, MSD, HSD	Three (3) years from the date of shipment.
KCAP, KTR	Five (5) years from the date of shipment.
All Other Products	One (1) year of useful service, not to exceed 18 months from the date of shipment.

The foregoing limited warranty is TCI’s sole warranty with respect to its products and TCI makes no other warranty, representation or promise as to the quality or performance of TCI’s products. **THIS EXPRESS LIMITED WARRANTY IS GIVEN IN LIEU OF AND EXCLUDES ANY AND ALL EXPRESS OR IMPLIED WARRANTIES INCLUDING, WITHOUT LIMITATION, ANY IMPLIED WARRANTY OF MERCHANTABILITY OR FITNESS FOR A PARTICULAR PURPOSE.**

This warranty shall not apply if the product was:

- a) altered or repaired by anyone other than TCI;
- b) applied or used for situations other than those originally specified; or
- c) subjected to negligence, accident, or damage by circumstances beyond TCI’s control, including but not limited to, improper storage, installation, operation or maintenance.

If, within the warranty period, any product shall be found in TCI’s reasonable judgment to be defective, TCI’s liability and the Buyer’s exclusive remedy under this warranty is expressly limited, at TCI’s option, to (i) repair or replacement of that product, or (ii) return of the product and refund of the purchase price. Such remedy shall be Buyer’s sole and exclusive remedy. **TCI SHALL NOT, IN ANY EVENT, BE LIABLE FOR INCIDENTAL DAMAGES OR FOR CONSEQUENTIAL DAMAGES INCLUDING, BUT NOT LIMITED TO, LOSS OF INCOME, LOSS OF TIME, LOST SALES, INJURY TO PERSONAL PROPERTY, LIABILITY BUYER INCURS WITH RESPECT TO ANY OTHER PERSON, LOSS OF USE OF THE PRODUCT OR FOR ANY OTHER TYPE OR FORM OF CONSEQUENTIAL DAMAGE OR ECONOMIC LOSS.**

The foregoing warranties do not cover reimbursement for removal, transportation, reinstallation, or any other expenses that may be incurred in connection with the repair or replacement of the TCI product.

TCI will not accept the return of any product without its prior written approval. All freight charges to return any product shall be at purchaser’s expense. Please consult TCI Customer Service for instructions on the Return Authorization Procedure.

The employees and sales agents of TCI are not authorized to make additional warranties about TCI’s products. TCI’s employees and sales agents oral statements do not constitute warranties, shall not be relied upon by the Buyer and are not part of any contract for sale. All warranties of TCI embodied in this writing and no other warranties are given beyond those set forth herein.

Rev. 2/29/2016

Pre-installation Planning

Verify the Application

HSD Ratings

Make sure that the HSD filter is correct for the application. The voltage ratings of the filter must match the input voltage rating of the connected drive. The horsepower and current ratings of the filter must be appropriate for the connected load.

Select a Suitable Location

Environment

Locating the HSD in a suitable environment will help ensure proper performance and a normal operating life. Refer to the environmental specifications listed in Table 5 and/or noted on the drawings furnished with the unit.

Warning 	<p>Unless specifically labelled as approved for such use, this equipment is not suitable for use in an explosive atmosphere or in a "Hazardous (Classified) Location" as defined in article 500 of the National Electrical Code (NEC).</p>
---	--

Make sure that the installation location will not be exposed to corrosive or combustible airborne contaminants, excessive dirt or liquids. The unit is to be installed in an environment where it will not be exposed to:

- Corrosive liquids or gasses
- Explosive or combustible gases or dust
- Excessive airborne dirt and dust
- Excessive vibration [0.152 mm (0.006 in) displacement, 1G peak]

Working Space

Provide sufficient access and working space around the unit to permit ready and safe installation, operation and maintenance. Make sure that the installation conforms to all working space and clearance requirements of the National Electrical Code (NEC) and/or any other applicable codes. Provide sufficient unobstructed space to allow cooling air to flow through the unit.

The widest or deepest portion of the unit enclosure having ventilation openings must be a minimum of six inches from adjacent walls or other equipment. Any enclosure sides that do not have ventilation openings should be a minimum of three inches from adjacent walls or other equipment.

Power Wiring

When selecting a mounting location for the HSD filter, plan for the routing of the power wiring.

Route the conduit and wiring from the power source to the filter and then to the VFD.

Installation Guidelines

Mounting

Select a mounting area that will allow adequate cooling air flow and maintenance access.

Wiring

Cable Entry Locations

The enclosed HSD filters are not provided with enclosure wiring knockouts. A location can be selected at the time of installation. Typical or recommended cable entry locations are shown in the drawings section of this manual.

Field Wiring Connection Terminals

Compression type terminals (Lug Options) are available for 480V HSD filters 75HP and above and 600V HSD filters 100HP and above. The wire size capacity ranges and tightening torques for all field wiring connections are listed in Table 1.

Grounding

The HSD panel equipment-grounding lug must be connected to the ground of the wiring system. The equipment-grounding connection must conform to the requirements of the National Electrical Code (NEC) and/or any other codes that apply to the installation site. The ground connection must be made using a wire conductor. Metallic conduit is not a suitable grounding conductor. The integrity of all ground connections should be periodically checked.

Power Wiring

<p>Caution</p> 	<p>Use copper wire that is appropriate for the voltage and current rating of the equipment. The wire selection must conform to the requirements of the National Electrical Code (NEC) and/or other applicable electrical codes. Use copper wire with an insulation temperature rating of 90°C or higher.</p>
---	--

Connect three-phase power of the appropriate voltage and current capacity to the circuit protective device to the HSD input power terminals. Use copper wire with an insulation temperature rating of 90°C or higher.

Note: in large units, the input power conductors are connected directly to the input terminals on the line reactors.

Connect the output terminals of the HSD to the input power terminals of the VFD.

Note: in large units, the output power conductors are connected directly to the output terminals on the line reactors. Refer to the VFD installation instructions for additional information.

Connections

Before Connecting

Always consult the drive manufacturer’s safety, installation and operation instructions prior to connecting the HarmonicShield® to the drive.



Warning 	Avoid contact with line voltage when checking for power. Failure to follow the safety instructions set forth in this manual can result in serious injury or death.
Warning 	Exercise caution when connecting the filter to the drive. Internal filter components may carry dangerous voltage which can cause death or serious injury upon contact.

Table 1 – Motor Power Terminal Wire Size Capacity Range and Tightening Torque (Cu)

Unit		Line/Load Connections		Ground Connection	
Hp	Std. Lug Kit P/N	Wire Range**	Torque in-lbs (N-m)	Wire Range**	Torque in-lbs (N-m)
3 to 30 at 480 Volt	N.A.*	18 AWG - 4 AWG	30 in-lbs (3.4 N-m)	Two 14 AWG to 2/0	45 in-lbs (5.1 N-m)
3 to 50 at 600 Volt	N.A.*	18 AWG - 4 AWG	30 in-lbs (3.4 N-m)	Two 14 AWG to 2/0	45 in-lbs (5.1 N-m)
40 to 60 at 480 Volt	N.A.*	18 AWG - 4 AWG	35 in-lbs (4 N-m)	Two 14 AWG to 2/0	50 in-lbs (5.6 N-m)
60 & 75 at 600 Volt	N.A.*	18 AWG - 4 AWG	35 in-lbs (4 N-m)	Two 14 AWG to 2/0	50 in-lbs (5.6 N-m)
75 at 480 Volt	LK00	2/0 - 14 AWG	50 in-lbs (5.6 N-m)	Two 14 AWG to 2/0	50 in-lbs (5.6 N-m)
100 at 480 Volt	LK01	2/0 - 14 AWG	50 in-lbs (5.6 N-m)	Two 14 AWG to 2/0	50 in-lbs (5.6 N-m)
100 at 600 Volt	LK00	2/0 - 14 AWG	50 in-lbs (5.6 N-m)	Two 14 AWG to 2/0	50 in-lbs (5.6 N-m)
125 at 480 Volt & 150 at 600 Volt	LK02	250kcmil - 6 AWG	375 in-lbs (42 N-m)	Two 14 AWG to 2/0	50 in-lbs (5.6 N-m)
125 at 600 Volt	LK01	2/0 - 14 AWG	50 in-lbs (5.6 N-m)	Two 14 AWG to 2/0	50 in-lbs (5.6 N-m)
150 to 250 at 480 Volt	LK03	600kcmil - 4 AWG	500 in-lbs (56 N-m)	Two 14 AWG to 2/0	50 in-lbs (5.6 N-m)
200 to 300 at 600 Volt	LK03	600kcmil - 4 AWG	500 in-lbs (56 N-m)	Two 14 AWG to 2/0	50 in-lbs (5.6 N-m)
300 to 400 at 480 Volt	LK04	Two 350kcmil - 6 AWG	375 in-lbs (42 N-m)	Two 14 AWG to 2/0	50 in-lbs (5.6 N-m)
350 to 500 at 600 Volt	LK04	Two 350kcmil - 6 AWG	375 in-lbs (42 N-m)	Two 14 AWG to 2/0	50 in-lbs (5.6 N-m)
450 & 500 at 480 Volt	LK05	Two 600kcmil - 4 AWG	500 in-lbs (56 N-m)	Two 350MCM - 6 AWG	375 in-lbs (42 N-m)
600 at 480 & 600 Volt	LK06	Three 600kcmil - 2AWG	375 in-lbs (42 N-m)	Two 350MCM - 6 AWG	375 in-lbs (42 N-m)

*For HSD units 60Hp and under no lug kit is available. Instead field connections are made to the reactor mounted standard option terminal block.

**Wire range specified is lug wire range. Follow NEC guidelines to determine minimum acceptable wire ampacity required for application.

Table 2 – Optional Contactor

Unit	Contactor Control Connection (optional)	
HP	Wire Range	Torque in-lbs (N-m)
All Units	22AWG - 12 AWG	5 in-lbs (0.56 N-m)

HSD Filter Operation

Caution 	Thoroughly check the installation before applying power and operating the equipment for the first time.
---	---

Before Applying Power for the First Time

Inspect the installation to make sure that all equipment has been completely and correctly installed in accordance with the ***Installation Guidelines*** section of this manual.

- Check to make sure power and ground connections are torqued to recommended torque value.
- Check to make sure the enclosure openings on the bottom and the top of the unit are not blocked or partially obstructed.
- If the HSD unit includes the optional tuned circuit control contactor, confirm the contactor relay coil is wired to 110VAC control power.

Operation

Since the HSD is a passive filter, the HSD is always energized and operating whenever the input to the drive is energized.

Installation

Intended Audience

This manual is intended for use by all personnel responsible for the installation, operation and maintenance of the HSD filters. Such personnel are expected to have knowledge of electrical wiring practices, electronic components and electrical schematic symbols.

Additional Information

Caution 	<p>This manual provides general information describing your HSD filter. Be sure to carefully review the more specific information that is provided by the drawings shipped with the unit. Information provided by the drawings takes precedence over the information provided in this manual.</p> <p>The ratings, dimensions and weights given in this manual are approximate and should not be used for any purpose requiring exact data. Contact the factory in situations where certified data is required. All data is subject to change without notice.</p>
---	--

Installation Checklist

The following are the key points to be followed for a successful installation. These points are explained in detail in the following sections of this manual.

- Make sure that the installation location will not be exposed to corrosive or combustible airborne contaminants, excessive dirt or liquids. The unit must be installed in an environment where it will not be exposed to:
 - Corrosive liquids or gasses
 - Explosive or combustible gasses or dust
 - Excessive airborne dirt and dust
 - Excessive vibration [0.152 mm (0.006 in) displacement, 1G peak]
- Select a mounting area that will allow adequate cooling air and maintenance access.
- Make sure that all wiring conforms to the requirements of the National Electrical Code (NEC) and/or other applicable electrical codes.
- Connect the HSD equipment-grounding lug to the system ground of the premises wiring system. Use a properly sized grounding conductor. Ground lug is optional and will not be present if the lugs option is not selected.
- Connect three-phase power to the input terminals of the HSD L1, L2 & L3.
- Connect the output power terminals of the HSD T1, T2 & T3 to the input power terminals of the VFD.

Maintenance and Service

HSD Filter Reliability and Service Life

The HSD has been designed to provide a service life that equals or exceeds the life of the VFD. It has been thoroughly tested at the factory to ensure that it will perform reliably from the time it is put into service. It is recommended that the following maintenance is performed once a year to ensure that the HSD filter will always operate reliably and provide the expected service life.

Periodic Maintenance

<p>Warning</p> 	<p>Only qualified electricians should carry out all electrical installation and maintenance work on the HSD filter.</p> <p>Disconnect all sources of power to the drive and HSD before working on the equipment. Do not attempt any work on a powered HSD.</p>
---	--

Check to see that the installation environment remains free from exposure to excessive dirt and contaminants. Refer to the *Pre-installation Planning* section of this manual.

Check to make sure that the enclosure ventilation openings are clean and unobstructed.

All electrical connections must be re-torqued annually.

Troubleshooting

<p>Warning</p> 	<p>Only qualified electricians should carry out all electrical installation and maintenance work on the HSD filter.</p> <p>Disconnect all sources of power to the drive and HSD before working on the equipment. Do not attempt any work on a powered HSD filter.</p> <p>The harmonic filter contains high voltages and capacitors. Wait at least five minutes after disconnecting power from the filter before you attempt to connect or disconnect the harmonic filter. Check for zero voltage between all terminals.</p> <p>All work on the HSD must be performed by a qualified electrician. Failure to follow standard safety procedures may result in death or serious injury.</p>
--	--

Note: when disconnecting wires from terminations, mark the wires to correspond to their terminal connection.

Service

Your HSD has no user serviceable parts. If your HSD requires service, it must be returned to TCI or taken to an authorized TCI service technician.

Factory Contacts and Tech Support

For technical support, contact your local TCI distributor or sales representative. You can contact TCI directly at 800-TCI-8282. Select "Customer Service" or "Tech Support" and have your HSD filter nameplate information available.

Product Description

HSD Drive-Applied Filter

The HSD is a drive-applied harmonic filter designed and developed by TCI to reduce the harmonic currents drawn from the power source by VFDs. The published HSD voltage, Power (Hp or kW) and current ratings apply to matching power (Hp or kW) rated standard VFDs with six-pulse diode bridge rectifiers. The HSD may also be sized to filter other loads such as SCR six-step drives, SCR Direct Current (DC) motor drives, thyristor furnaces, battery chargers, electroplating supplies or other types of non linear loads. In many cases, the filter power rating (Hp or kW) will differ from load power rating (Hp or kW). Please contact TCI Technical Support for additional information and support on sizing HSD harmonic filters for your non six-pulse diode front end VFD applications.

The HSD is a passive filter connected in series with the input terminals of a VFD or several VFDs that operate as a group. It is designed to provide a low impedance path for the major harmonic currents demanded by the drive. The filter is a stand-alone device that is furnished in its own enclosure and mounted adjacent to the drive.

The HSD filters consist minimally of the following features and components:

- A KDR tuned series reactor to prevent system interaction and improve filter performance
- An L-C-L filter circuit with:
 - A TCI 3-phase tuning reactor specifically designed for the HSD filter
 - High-endurance, harmonic-rated capacitors
 - Bleeder resistors to ensure safe capacitor discharge upon filter shutdown

Filter Configuration

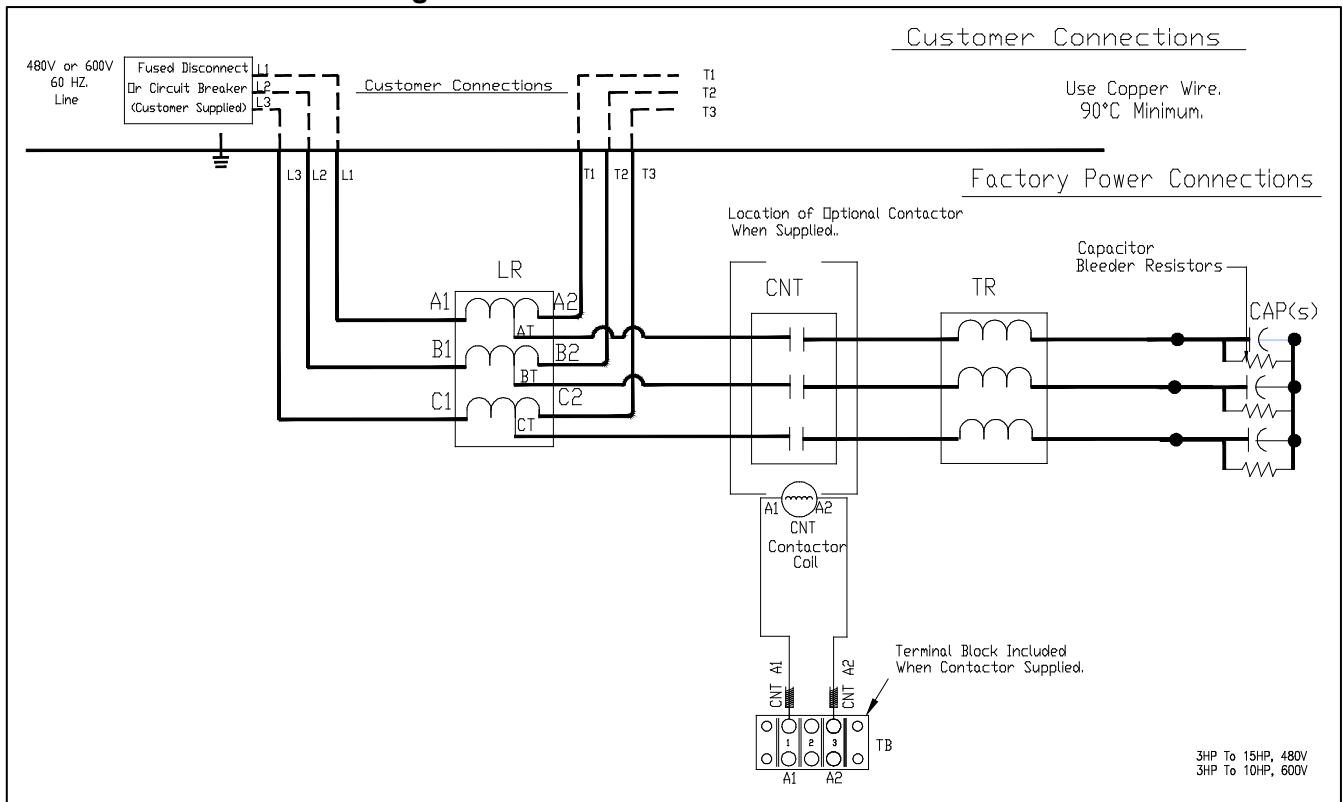

Figure 1: HSD Connection Diagram 3HP to 10HP

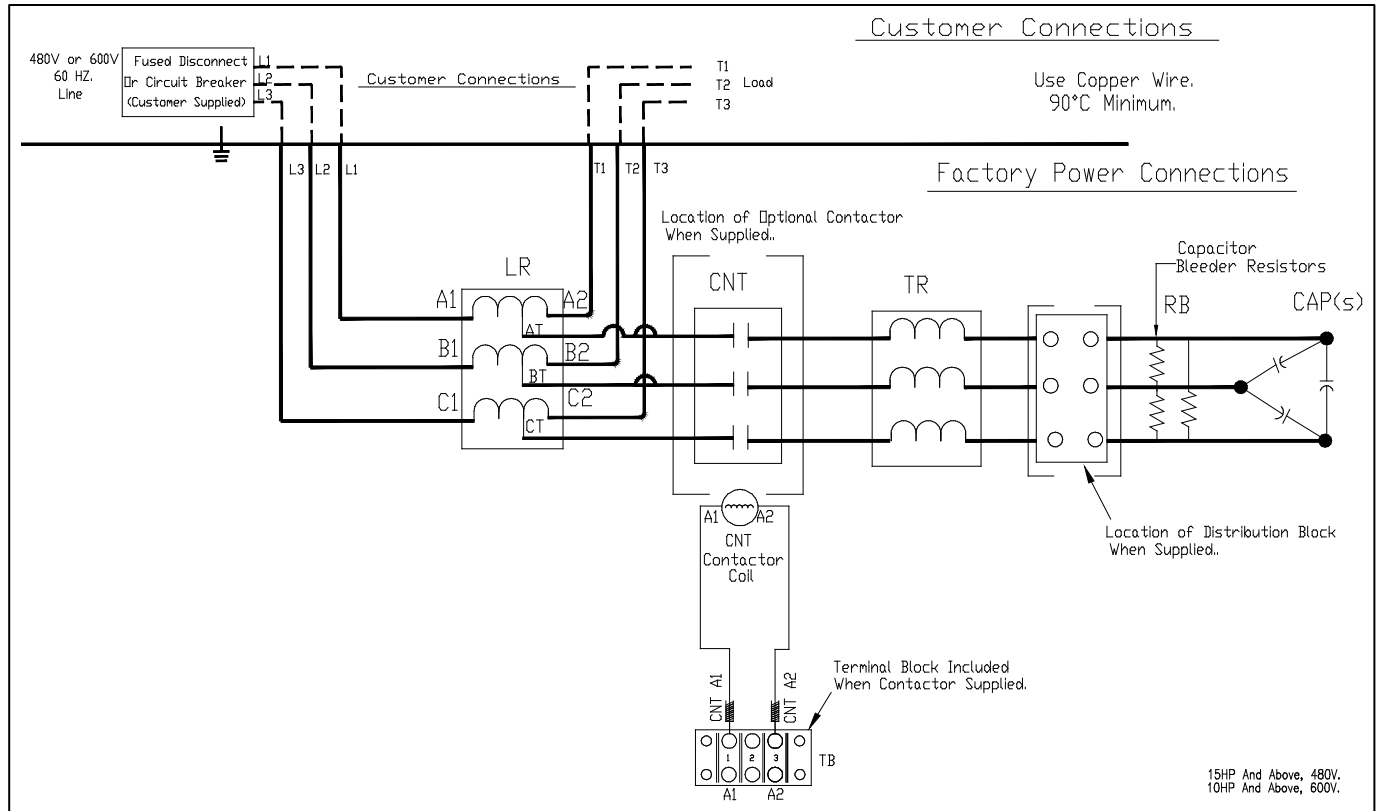

Figure 2: HSD Connection Diagram 15HP and Above

Nameplate Data

The following information is marked on the nameplate:

- Part number: encoding is explained on the following page
- FLA: the rated continuous operating current (RMS amps)
- System Voltage: the rated 3-phase line voltage (RMS volts)
- Hz: the rated frequency (60 Hz)
- Phase: 3 – The HSD filter is designed for use only with 3-phase power.
- Drawing #: outline and mounting dimension drawing number
- Schematic #: schematic diagram drawing number
- Manufacturing #: for TCI internal use
- Enclosure Type: UL designation

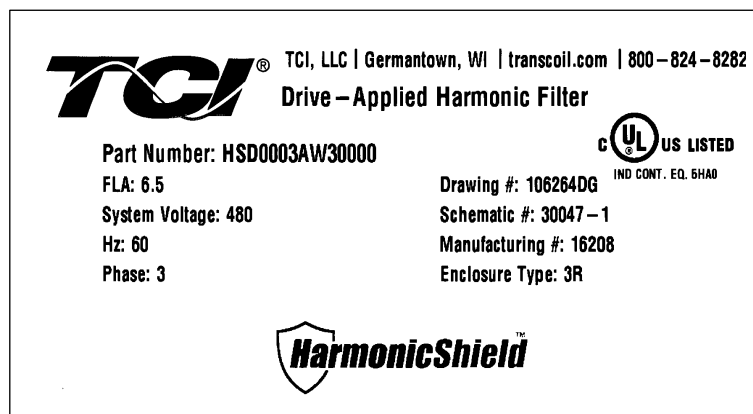

Figure 3: HarmonicShield® Nameplate

Part Number Encoding

Figure 4 identifies the significance of each character in the HSD part number. The example part number, HSD0150AW30000 designates an HSD filter that is rated 150 HP, 480 volts, 60 Hz. It includes a line reactor, tuning reactor, and capacitors in a UL Type 3R enclosure. It is designed for use with a 150 HP drive.

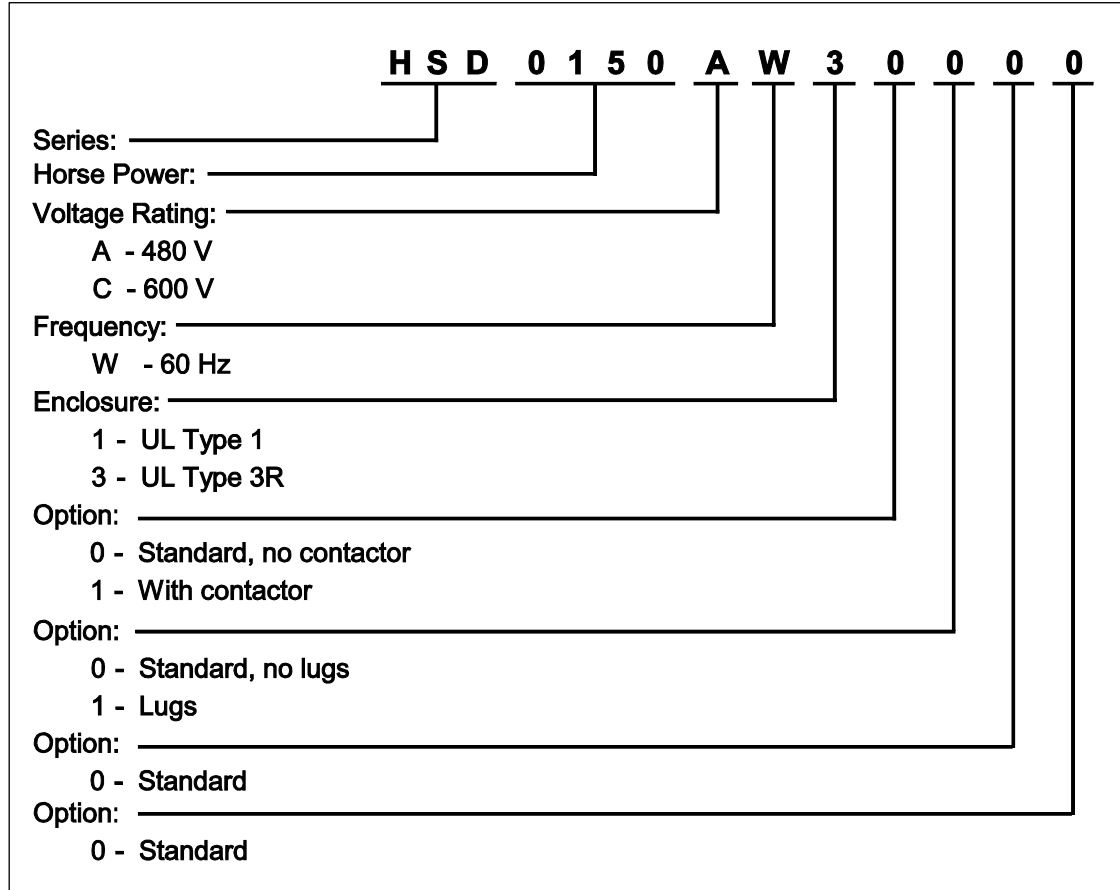

Figure 4 – HSD Part Number Encoding

Standard Product Ratings and Dimension Tables

The following table list the ratings and dimensions of the standard HarmonicShield® models:

Table 3 – 480V HSD Standard Ratings and Dimensions

Size	Rating	Lug Kit	Losses	Enclosure	HEIGHT	WIDTH	DEPTH	WEIGHT	WEIGHT w/contactors
(HP)	(Max Load Amps)*	(-)	(W)	(-)	(in.)	(in.)	(in.)	(lbs.)	(lbs.)
3	6.5	NA	110	E3R2-TALL	25.12	15.43	19.50	60	63
5	8	NA	150	E3R2-TALL	25.12	15.43	19.50	60	63
7.5	12	NA	150	E3R2-TALL	25.12	15.43	19.50	77	80
10	16	NA	175	E3R2-TALL	25.12	15.43	19.50	77	80
15	23	NA	250	E3R2-TALL	25.12	15.43	19.50	85	88
20	31	NA	275	E3R2-TALL	25.12	15.43	19.50	90	93
25	38	NA	250	E3R2-TALL	25.12	15.43	19.50	93	95
30	49	NA	300	E3R2-TALL	25.12	15.43	19.50	102	105
40	62	NA	500	E3R2-TALL	25.12	15.43	19.50	143	146
50	73	NA	550	E3R2-TALL	25.12	15.43	19.50	143	146
60	85	NA	675	E3R3-S	22.12	20.43	28.50	185	188
75	105	LK00	650	E3R3-S	22.12	20.43	28.50	186	189
100	140	LK01	750	E3R3-S	22.12	20.43	28.50	235	238
125	170	LK02	1033	E3R3-TALL	40.00	20.70	28.50	300	305
150	209	LK03	1126	E3R3-TALL	40.00	20.70	28.50	346	350
200	257	LK03	1136	E3R4-S	36.00	28.39	36.86	500	510
250	321	LK03	1184	E3R4-S	36.00	28.39	36.86	503	512
300	405	LK04	1583	E3R5	60.12	36.27	44.55	765	780
350	445	LK04	1745	E3R5	60.12	36.27	44.55	805	819
400	483	LK04	2036	E3R5	60.12	36.27	44.55	960	975
450	540	LK05	2111	E3R5	60.12	36.27	44.55	1115	1130
500	637	LK05	2341	E3R5	60.12	36.27	44.55	1125	1140
600	790	LK06	2700	E3R5	60.12	36.27	44.55	1195	1220

*HSD Max Load Amps assumes motor Power Factor loading (0.78 lagging power factor).

Table 4 – 600V HSD Standard Ratings and Dimensions

Size	Rating	Lug Kit	Losses	Enclosure	HEIGHT	WIDTH	DEPTH	WEIGHT	WEIGHT w/contactors
(HP)	(Max Load Amps)*	(-)	(W)	(-)	(in.)	(in.)	(in.)	(lbs.)	(lbs.)
3	3.7	NA	132	E3R2-TALL	25.12	15.43	19.50	60	63
5	6.1	NA	170	E3R2-TALL	25.12	15.43	19.50	60	63
7.5	9	NA	170	E3R2-TALL	25.12	15.43	19.50	77	80
10	11	NA	220	E3R2-TALL	25.12	15.43	19.50	77	80
15	17	NA	300	E3R2-TALL	25.12	15.43	19.50	85	88
20	21	NA	325	E3R2-TALL	25.12	15.43	19.50	90	93
25	28	NA	355	E3R2-TALL	25.12	15.43	19.50	93	95
30	34	NA	425	E3R2-TALL	25.12	15.43	19.50	102	105
40	44	NA	675	E3R2-TALL	25.12	15.43	19.50	143	146
50	53	NA	700	E3R2-TALL	25.12	15.43	19.50	143	146
60	66	NA	900	E3R3-S	22.12	20.43	28.50	185	188
75	83	LK00	1000	E3R3-S	22.12	20.43	28.50	186	189
100	103	LK01	1050	E3R3-S	22.12	20.43	28.50	235	238
125	129	LK02	1200	E3R3-TALL	40.00	20.70	28.50	300	305
150	166	LK03	1500	E3R3-TALL	40.00	20.70	28.50	346	350
200	209	LK03	1850	E3R4-S	36.00	28.39	36.86	500	510
250	242	LK03	2000	E3R4-S	36.00	28.39	36.86	503	512
300	321	LK04	2500	E3R5	60.12	36.27	44.55	765	780
350	350	LK04	2800	E3R5	60.12	36.27	44.55	805	819
400	404	LK04	2700	E3R5	60.12	36.27	44.55	960	975
450	420	LK05	3050	E3R5	60.12	36.27	44.55	1115	1130
500	482	LK05	3000	E3R5	60.12	36.27	44.55	1125	1140
600	636	LK06	3200	E3R5	60.12	36.27	44.55	1195	1220

*HSD Max Load Amps assumes motor Power Factor loading (0.78 lagging power factor).

Product Technical Specifications

Table 5 lists the major technical specifications for the HSD Filter.

Table 5 – HSD Technical Specifications

Voltage ratings	480V, 3 phase, 60 Hz / 600V, 3 phase, 60 Hz
kVar ratings	0.9 to 180 kVar depending on horsepower.
Load types	3-phase diode bridge rectifier loads such as PWM AC drives
Load power range	3 -600 HP
Current ratings	The included series reactors can tolerate 200% of rated current for up to 3 minutes.
Maximum elevation	3,300 feet (1,000 meters) as standard.
Maximum ambient operating temperature	40°C (104°F) Product must be equipped with special cooling provisions for operation above this temperature.
Minimum ambient operating temperature	-40°C (-40°F)
Maximum ambient storage temperature	60°C (140°F)
Maximum humidity, operating or storage	95%, non-condensing.
Enclosure options	UL Type 1 and Type 3R
Agency approvals or certifications	cUL US Listed to UL508 
Insertion Impedance	+/- 10% at full load current
Performance Guarantee	
<p>To meet the requirements for the Performance Guarantee the minimum system conditions must conform to the following:</p> <ul style="list-style-type: none"> • No more than 1.5% Source inductance • The input VFD current waveform shall be consistent with that of a VFD with 3% AC line reactance at full load 	

NOTE: The HarmonicShield® filter is UL Listed as an Auxiliary Device in accordance with PART X of UL 508 Standard for Industrial Control Equipment and does not require a SCCR rating or marking. HSD is not an Industrial Control Panel and so does not require a Short Circuit Current Rating such as is required of Industrial Control Panels to be in compliance with NFPA NEC Article 409. For applications requiring a SCCR rating, TCI offers the HGP product which features the same performance as the HSD and is an Industrial Control Panel with a true SCCR rating of 100ka.

Standard Option (S)

The Standard Option includes high quality harmonic grade capacitors and a line reactor. This filter will meet the majority of application requirements found today. This cost effective product is available in a floor mounted, indoor/outdoor UL Type 1 or Type 3R enclosure. This design is perfect for applications where floor space is at a premium. The UL Type 3R enclosure protects the filter from harsh conditions.

Product Description

Standard

The HSD is a drive-applied harmonic filter designed and developed by TCI to reduce the harmonic currents drawn from the power source by VFDs. The published HSD voltage, Power (Hp or kW) and current ratings apply to matching power (Hp or kW) rated standard VFDs with six-pulse diode bridge rectifiers. The HSD may also be sized to filter other loads such as SCR six-step drives, SCR Direct Current (DC) motor drives, thyristor furnaces, battery chargers, electroplating supplies or other types of non linear loads. In many cases the filter power rating (Hp or kW) will differ from load power rating (Hp or kW). Please contact TCI Technical Support for additional information and support on sizing HSD harmonic filters for your non six-pulse diode front end VFD applications.

The HSD harmonic filter is a passive filter connected in series with the input terminals of a VFD or several VFDs that operate as a group. It is designed to provide a low impedance path for the major harmonic currents demanded by the VFD. The filter is a stand-alone device that can be furnished in its own enclosure and mounted adjacent to the VFD.

The HSD Standard Option consists of the following standard features and components:

- A KDR tuned series reactor.
- A TCI 3-phase tuning reactor specifically designed for the HSD filter.
- High-endurance, harmonic-rated capacitors.
- Bleeder resistors to ensure safe capacitor discharge upon filter shutdown, located on capacitors.

Contacting Option (C)

The Contacting Option includes a single contactor, which allows the VFD user to control the insertion of this circuit through the use of a relay contact in the VFD. The customer will supply a separate 120v source to a terminal block which feeds the contactor. It is recommended that the VFD contact be programmed to open the contactor below 33% motor power. For variable torque (fan) loads this will be approximately below 70% speed, so the at-speed contact may be used. This reduces the possibility of leading power factor interacting with other devices on the power system. Contacting logic should also maintain the contactor closed in cases where the VFD is bypassed and the filter is not bypassed.

Contacting

The HSD is a drive-applied harmonic filter designed and developed by TCI to reduce the harmonic currents drawn from the power source by VFDs. The published HSD voltage, Power (Hp or kW) and current ratings apply to matching power (Hp or kW) rated standard VFDs with six-pulse diode bridge rectifiers. The HSD may also be sized to filter other loads such as SCR six-step drives, SCR Direct Current (DC) motor drives, thyristor furnaces, battery chargers, electroplating supplies or other types of non linear loads. In many cases the filter power rating (Hp or kW) will differ from load power rating (Hp or kW). Please contact TCI Technical Support for additional information and support on sizing HSD harmonic filters for your non six-pulse diode front end VFD applications.

The HSD harmonic filter is a passive filter connected in series with the input terminals of a VFD or several VFDs that operate as a group. It is designed to provide a low impedance path for the major harmonic currents demanded by the VFD. The filter is a stand-alone device that can be furnished in its own enclosure and mounted adjacent to the VFD.

The HSD Contacting Option consists of the following standard features and components:

- A KDR tuned series reactor.
- A TCI 3-phase tuning reactor specifically designed for the HSD filter.
- High-endurance, harmonic-rated capacitors.
- Bleeder resistors to ensure safe capacitor discharge upon filter shutdown, located on capacitors.
- Contacting

For proper operation of the HarmonicShield® optional tuned circuit control contacting, please insure your control source has the pull-in and steady state Volt Amp (VA) rating specified in Table 6.

Table 6- HSD Tuned Circuit Control Contacting Option Coil Requirements

	480v		600v	
	Required VA		Required VA	
HP	Inrush	Sealed	Inrush	Sealed
3	45	6	45	6
5	45	6	45	6
7.5	45	6	45	6
10	45	6	45	6
15	45	6	45	6
20	45	6	45	6
25	45	6	45	6
30	45	6	45	6
40	88	9	88	9
50	88	9	88	9
60	88	9	88	9
75	191	17	88	9

	480v		600v	
	Required VA		Required VA	
HP	Inrush	Sealed	Inrush	Sealed
100	191	17	191	17
125	191	17	191	17
150	191	17	191	17
200	350	20	350	20
250	350	20	350	20
300	425	20	350	20
350	425	20	425	20
400	425	20	425	20
450	425	20	425	20
500	425	20	425	20
600	750	25	750	25

Lugs Option (L)

The Lug Option is available for 480V HSD filters 75HP and above and 600V HSD filters 100HP and above. The lug kits include 3 in / 3 out and a ground lug along with all necessary mounting hardware. The lug option can be ordered pre-installed at our factory or may be ordered separately as a customer installed kit.

Lugs

TCI has selected FLEX wire class G-K, UL listed at 600V, 90°C temperature rating premium quality CSA certified, single, double and triple wire lugs. Flex rating applies to units through 500HP.

Filter Operation

HSD Filter Overview

The HarmonicShield® (HSD) Filter provides a low impedance path for the major harmonic currents demanded by Variable Frequency Drives (VFDs). This greatly reduces the amount of harmonic currents flowing through the electrical power distribution system, bringing those harmonic currents in line with the IEEE-519 standard for harmonic distortion mandated by an increasing number of utilities.

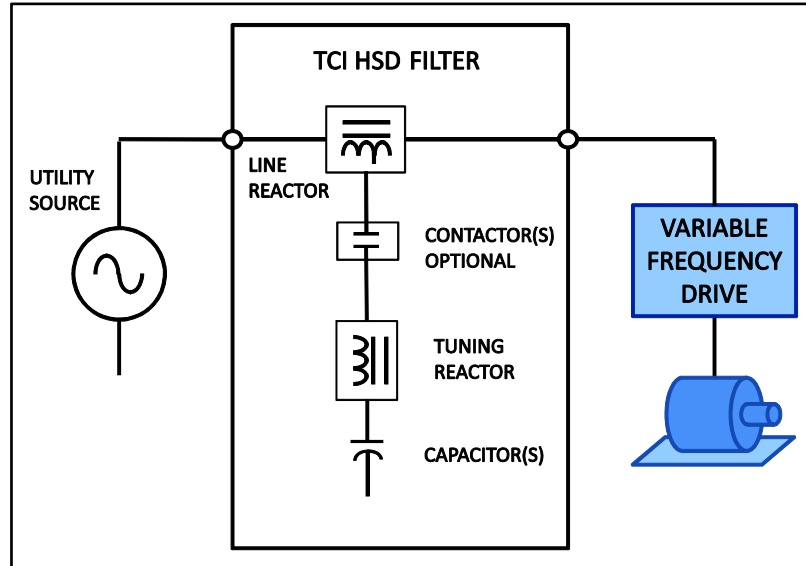

Figure 5 – HSD Filter Block Diagram



TCI, LLC
W132 N10611 Grant Drive
Germantown, Wisconsin 53022

Phone: 414-357-4480
Fax: 414-357-4484
Helpline: 800-TCI-8282

Web Site: www.transcoil.com

© 2017 TCI, LLC All rights reserved

Publication No: 30208

Effective: 9/13/2017 Revision: D